



Khavar Engineering Co.

Engineering Service Experiences

By Commercial Department

Dec. 2019

Rich History to
Reach Brilliant
FUTURE



BFW



Hyosung

Audoli &
Bertola



تعمیرات و خدمات مهندسی



Sulzer

Lowara



KEC

شرکت مهندسی ماشین های دوار خاور طوس
KHAVAR TOOS ENGINEERING CO.



Hallberg

Sundyne
Compressor

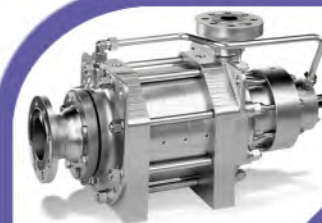

KSB- HGM
4-5

Worthington
DMX 8/4



Flowserve

Steel Industry



Description	Specification
Multistage high pressure pump (High-Low) (4 pcs.)	ITALIMPIANTI P524 B/C 450 m – 30 m ³ /hr



Overhaul and maintenance of wet parts and spare part manufacturer
Application : Hydraulic power for furnace cover

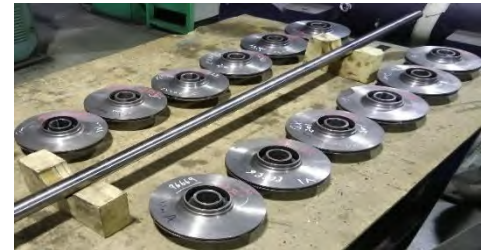
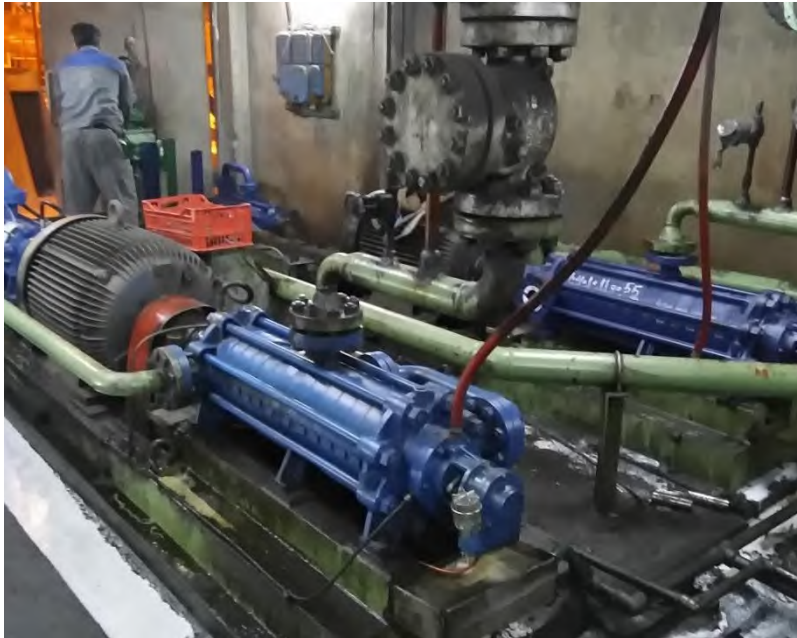

Description	Specification	
<p>Multistage high pressure pump (RO) (2 pcs.)</p>	<p>Duchting ROWA 150-500/4 525 m3/h - 670 m - 1200 kw</p>	

Material of construction: Duplex (1.4468)
Application: Reverse Osmosis main pump



Description	Specification	 <p>O&M شرکت بهره برداری و تعمیراتی مپنا</p>
Multistage high pressure pump (BFW) (7 pcs.)	Ingersoll Dresser –4HMTA 11 1140 m – 163 m³/hr – 140 C- 750 Kw	

Mega power plant fault detecting and retrofitting



Description	Specification	
<p>Multistage high pressure pump (BFW) (1 pcs.) (in-hand)</p>	<p>Ingersoll Dresser –4HMTA 11 1140 m – 163 m³/hr – 140 C- 750 Kw</p>	

KEC is a solution provider in a sensitive application



Description	Specification	 <p>شرکت بهره برداری و تعمیراتی مپنا نیروگاه پرند</p>
Multistage high pressure pump (BFW) (2 pcs.)	Hyosung 40 HRS G PJT 1200 m – 345 m³/hr – 158 C – 1400 KW	

Hyosung boiler feed water pump **API** standard



Description	Specification	 <p>O&M شرکت بهره برداری و تعمیراتی مپنا</p>
Multistage high pressure pump (BFW)	Torishima MHG 5/8 1185 m – 305 m³/hr – 158° C- 1250 Kw	

Torishima, High pressure **API**, Boiler feed pump



Description	Specification	
<p>Multistage high pressure pump Casing (BFW)</p>	<p>Torishima MHG 5/8 1185 m – 305 m³/hr – 158 C- 1250 Kw</p>	

Solution providing to prevent to frequenting erosion

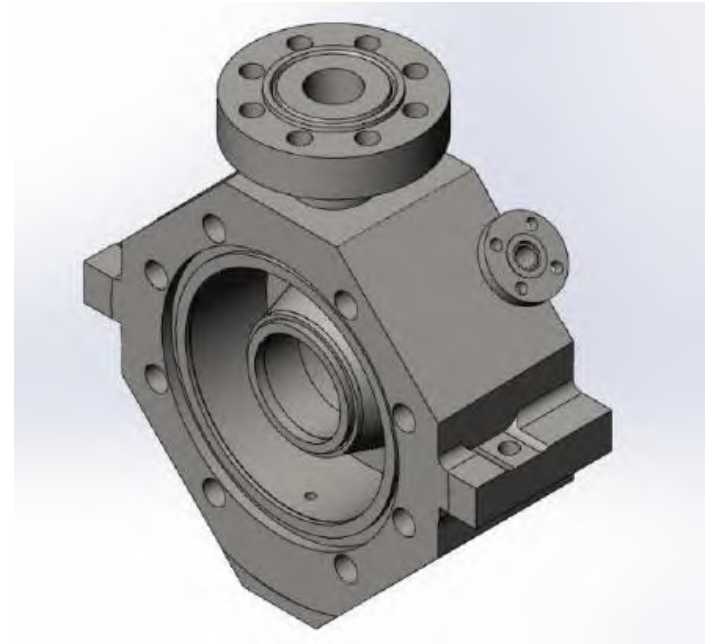

Description

Specification

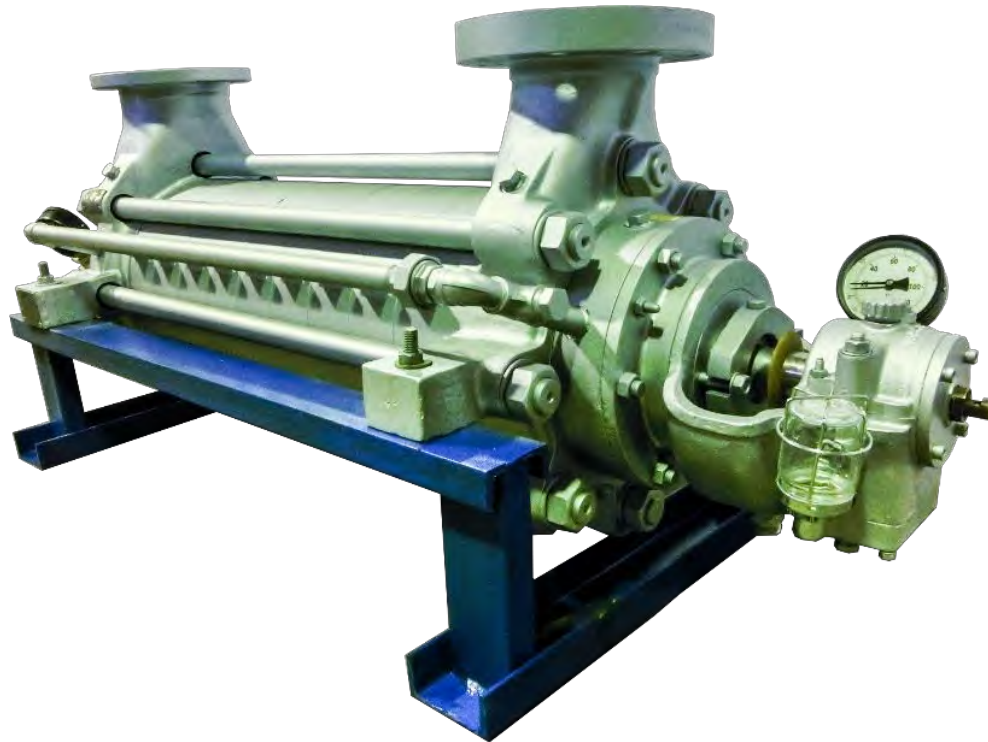
**Multistage high pressure pump
(BFW)****Hallberg HKGM 100-10
730 m – 100 m³/hr – 140 C – 355 Kw**

عارضه یابی بازسازی و ساخت تمامی قطعات
روتاری

Description

Specification

Multistage high pressure pump
(BFW)
(in-hand)

KSB HGM 4-5
822 m – 100 m³/hr – 130 C

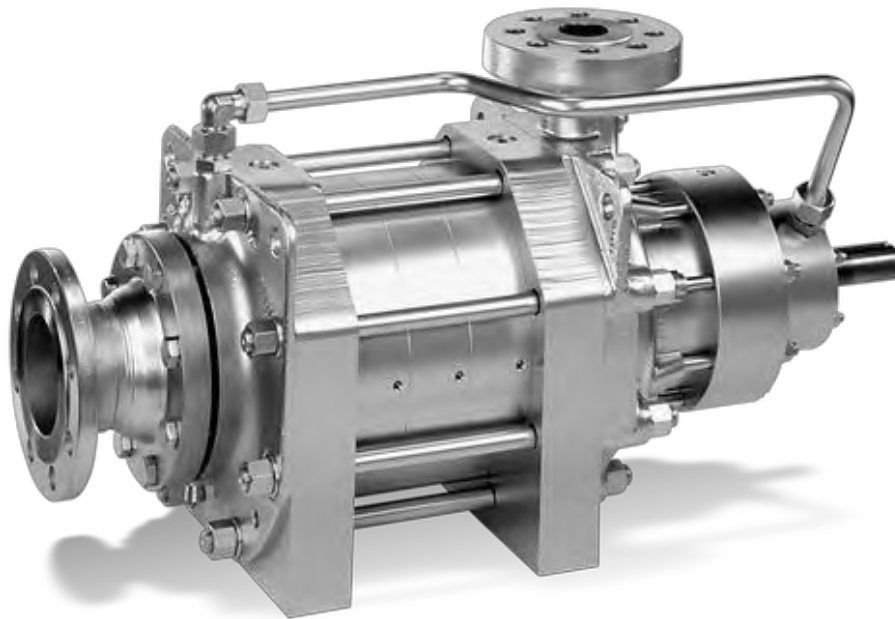

ساخت قطعات و بازسازی و استخراج
تکنولوژی یکی از جدیدترین انواع پمپ
های طبقاتی فشار بالا جهت کاربرد در
سیستم های تصفیه آب به روش RO

Description	Specification	 <p>شرکت آب و برق کیش (سهامی خاص) Kish Water & Power Co</p>
<p>Multistage high pressure pump (RO) (2 pcs.)</p>	<p>Garbarino 125 rG3 384 M3/h – 240 m - 400 kw Line</p>	

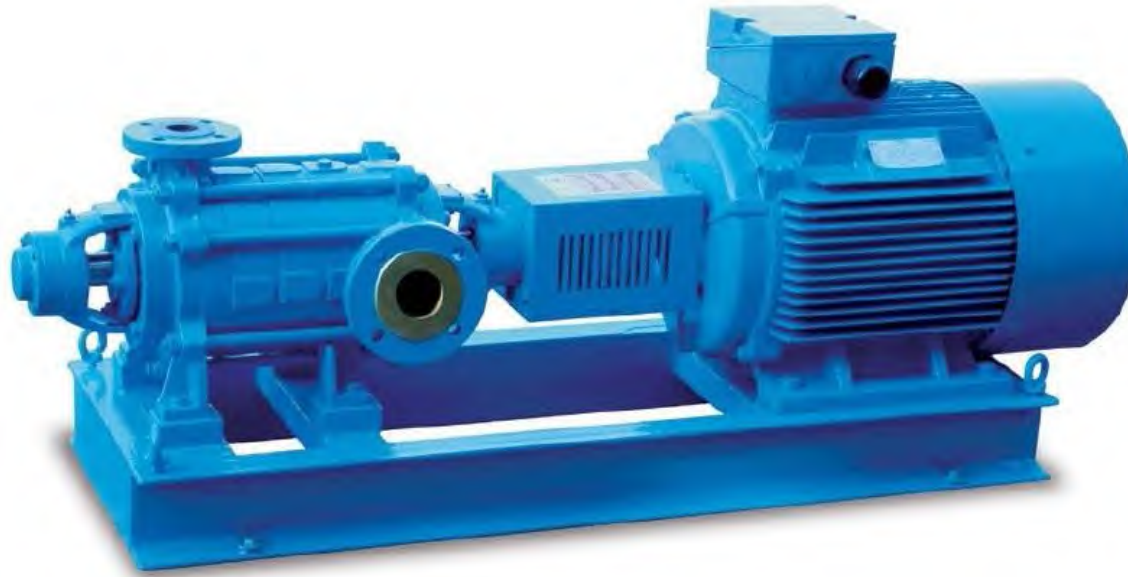

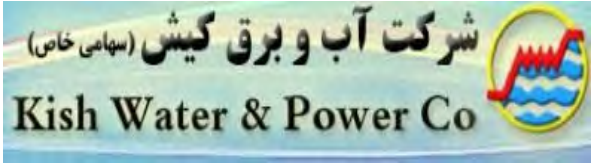
Description	Specification	
Multistage high pressure pump (RO) (3 pcs.)	Sulzer MB 80-230/7 115 M3/hr – 560 m - 250 kw	

اصلاح ساختار



Xylm (Vogel) low NPSH Multistage Pump ,
 Spare parts Manufacture

Description	Specification	 شرکت آب و برق کیش (سهامی خاص) Kish Water & Power Co
Multistage high pressure pump (RO) (7 pcs.)	VOGEL MPA 40.2 / 4 S 14 M3/hr – 140 m	

Low NPSH, Inducer type SS316 (1.4408) Pump



Description	Specification	 شرکت آب و برق کیش (سهامی خاص) Kish Water & Power Co
Multistage high pressure pump (RO)	PEI - HSC 65 M3/h – 400 m - 160 kw	

تغییر ساختار پمپ، جانمایی **بالانس**
 پیستون به منظور افزایش عمر یاتاقان ها



Description	Specification	 شرکت مهندسی رعد آب جنوب South Raadab Engineering co.
Multistage high pressure pump (RO) (2 pcs.)	Audoli & Bertola TKR 125-150/3 stages 600 m – 500 m³/hr – 630 kw	

اصلاح ساختاری و تولید قطعات یدکی و تغییر سیستم آب بندی از
 پکینگ به سیل مکانیکی



Description	Specification	 شرکت قند تربت حیدریه
Multistage high pressure pump (BFW)	Halberg HKGB 100/10 730 m – 100 m³/hr – 140 C – 355 Kw	



تغییر فونداسیون بتنی قدیمی و ایجاد
 فونداسیون جدید
 بازسازی، اصلاح و بهبود، نصب، راه
 اندازی و تحلیل ارتعاشی

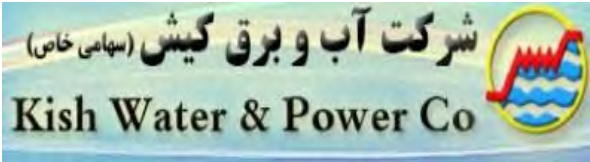

Description	Specification	 <p>شرکت آب و برق کیش (سهامی خاص) Kish Water & Power Co</p>
Pelton Turbine (RO) (5 Pcs.)	CALDER RO 350-65 HP	



بازسازی و ساخت قطعات توربین پلتون



Spare part manufacturing and Overhaul

Description	Specification	
Multistage high pressure pump API 610 BB4	STERLING MSMA 50/13 800 m – 11 m³/hr – 40 Kw	

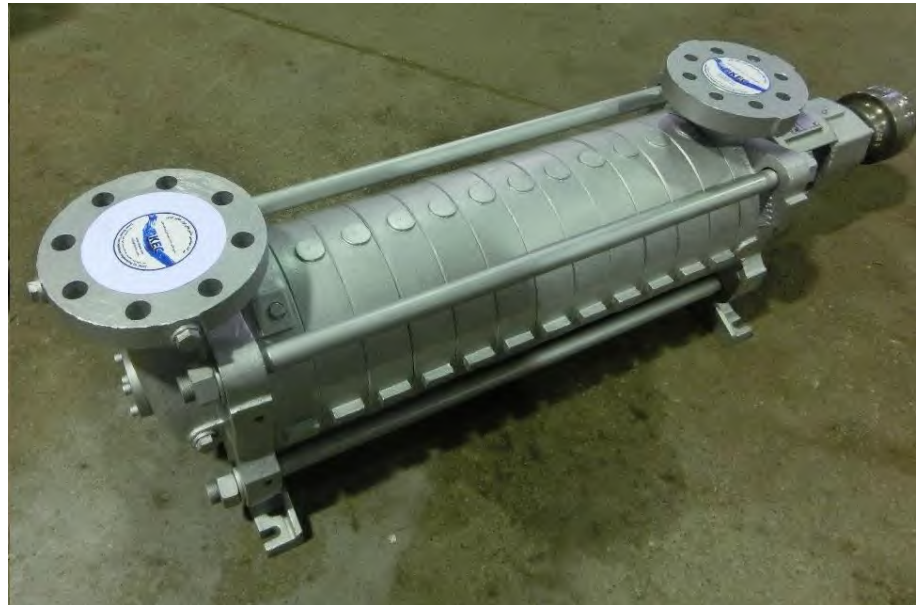

بازسازی پمپ شامل ساخت و تعویض شفت، اسلیوها - اصلاح بالانس درام و دیفوزرها - ساخت و تعویض بوش سیلیکون - تعویض رینگ های سایشی ، بالانس مجموعه شفت و قطعات روتاری و مونتاژ نهایی



Description	Specification		
<p>Multistage high pressure pump (API610 - BB5 - Crude Oil)</p>	<p>Flowserve - 4WXB 11B7 SUPPER DUPLEX 676 m – 65 m³/hr</p>		



پمپ های تزریق آب شور واحدهای نمک زدایی نفت با **TDS=58000**



Description	Specification	  <p>شرکت بهره برداری نفت و گاز کچاران شرکت ملی مناطق نفت خیز جنوب</p>
<p>Multistage high pressure pump (API610 –BB3 - Crude Oil) (3 pcs.)</p>	<p>Worthington DMX 8/4 H= 460 m Q=170 m3/hr</p>	

احیا ساختاری پمپ انتقال نفت خام با قدمت بیش از ۵۰ سال



Description	Specification	  شرکت بهره برداری نفت و گاز کچساران شرکت ملی مناطق نفت خیز جنوب	
Multistage high pressure pump (API610 –OH2 - Crude Oil) (2 pcs.)	CerPELLi HPEN 100-350 H= 130 m 203 m ³ /hr		

پمپ انتقال نفت خام



Description	Specification	 شرکت بهره برداری نفت و گاز کچاران
High Speed Compressor (API617 – OH6) (2 pcs.)	Sundyne compressor LMC 313 27000 rpm – 163 m3/hr	

بازسازی و اصلاح و بهبود کمپرسورهای سرعت بالای نفت و گاز به همراه **ساخت قطعات حساس**



Description	Specification	 <p>شرکت مجتمع گاز پارس جنوبی s.p.g.c پالایشگاه چهارم</p>
<p>High Speed integrally geared Compressor (4 Sets)</p>	<p>High tech. Japanese compressor KOBELCO VGP 100 44000 rpm - Medium pressure (4 stages)</p>	

اصلاح افت فاحش هوادهی و فشار کمپرسور و رساندن مشخصات عملکردی به مشخصات دقیق عملکردی دیتاشیت



Description	Specification	 شرکت مهندسی و ساخت تأسیسات دریائی
Sea water submersible electric lift pumps (2 pcs.)	SBH 80-22 H=100 m Q=50 m ³ /h P= 30 KW	

اصلاح ساختار و بازسازی پمپ های مستغرق آب شور جزایر نفتی به علت کمبود قطعات مکانیکی نظیر بوش و کف گرد و ژورنال بیرینگ ها و کابل ها و سنسورها



Description	Specification	
Multistage high pressure pump (API610 -BB5 - BFW)	CHTR 5/4 H=709 m Q=434 m³/h P= 1410 KW	



نظارت بر نصب و راه اندازی پمپ
آمین فشار بالا پالایشگاه گازی فاز
۱۷ و ۱۸ عسلویه

Description	Specification	
Multistage high pressure pump (Transferring Water)	Ritz 49-200/7/A3 450 m – 360 m³/hr - 355 kw	

بازسازی اورژانسی پمپ های فشار قوی تزریق آب شهر عسلویه در محل تلمبه خانه



Description	Specification	 لوله گستر اسفراین
Multistage high pressure pump (De-Scaling - Intermittent)	KSB KSB-HGB 3/7 600 m – 75 m ³ /hr – 200 Kw	

بازسازی پمپ های فشار قوی پوسته زداي لوله گستر اسفراین



Description	Specification	
Vertical turbine pumps	P18/3 Caprari (Italy) pumps	



نظارت بر نصب و اورهال و ساخت قطعات و راه اندازی مجدد پمپ های اروپایی فولاد مبارکه که در مرحله نصب و راه اندازی، به علت عیوب ناشی از فرآیند تولید متوقف شده بود.



Description	Specification	
Multistage high pressure pump (Transferring Water)	Sulzer CV200/3	

بازسازی پمپ های **دبی بالا** فشار بالای تلمبه خانه های **انتقال آب**



Refurbishment and design modification



Description	Specification	
(API610 –BB2 - Crude Oil)	Byron Jackson BB2	

بازسازی ، اصلاح و بهبود
تعهد گارانتی و دوره خدمات بعد از فروش
محصولات اروپایی همراه با تعهد ساخت قطعه در
دوران خدمات و پشتیبان مصرف کنندگان در طول
دوره عمر محصولات بازسازی شده

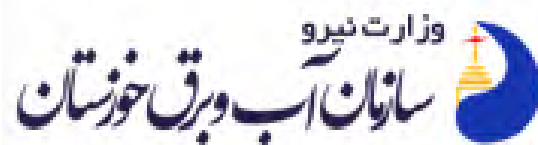

LCC Improvement life time of the rotary equipment KEC as Solution provider

Description	Specification	
Mixed flow Vertical Turbine Pump	Kubota 4-stage pump (1MW)	

پاسخ زودهنگام شرکت خاور به تغییرات شرایط محیطی تجهیزات دوار و اصلاح ساختاری هوشمند علمی متناسب با شرایط جدید محیطی محل نصب: رود کارون



Description	Specification	 Mobarakeh Steel Co.
Multistage high pressure pump (Barrel Type -BB5)	Termomeccanica MESB 5-stage pump (280 bar -400 m3/hr-3.7 MW)	

بهره گیری و هزینه کردن به منظور دستیابی به فرصت های در اختیار پمپ در صنایع بزرگ کشور به منظور شناخت حداکثری مبانی عملکردی و استخراج روش های تولیدی ماشین های دوار خاور



Repaired Parts: **Thrust bearing system modification report + Vibrational Analysis**

A comprehensive glance at all aspects of pump operation due to optimum LCC

Description	Specification	
Multistage high pressure pump (API610 -BB5 - Crude Oil)	Roodhart RCBB5 250-200-150 518 m3/h - 1127 m 2400 kw – 2950 rpm EX	

توان پکیجینگ و همراستاسازی محرک و متحرک تجهیزات دوار و کنترل عملکرد، راه اندازی و توقف آنها با سیستم های هیدرولیکی و ابزار دقیق



Description	Specification	
<p>Multistage high pressure pump (API610 -BB5 - Crude Oil)</p>	<p>Flowsereve 2WXB 7B10 SUPPER DUPLEX 366 m – 32 m³/hr</p>	

سه سال عملکرد بدون توقف

واحد نمک زدایی دارای حساسیت سرویس بالا



Description

Specification

Screw Fuel Injection Pump

Allweiler Screw VHF660R
80 Bar

شرکت بهره برداری و تعمیراتی مینا

نیروگاه چابهار

تعمیرات اساسی پمپ جابجایی مثبت تزریق گاز

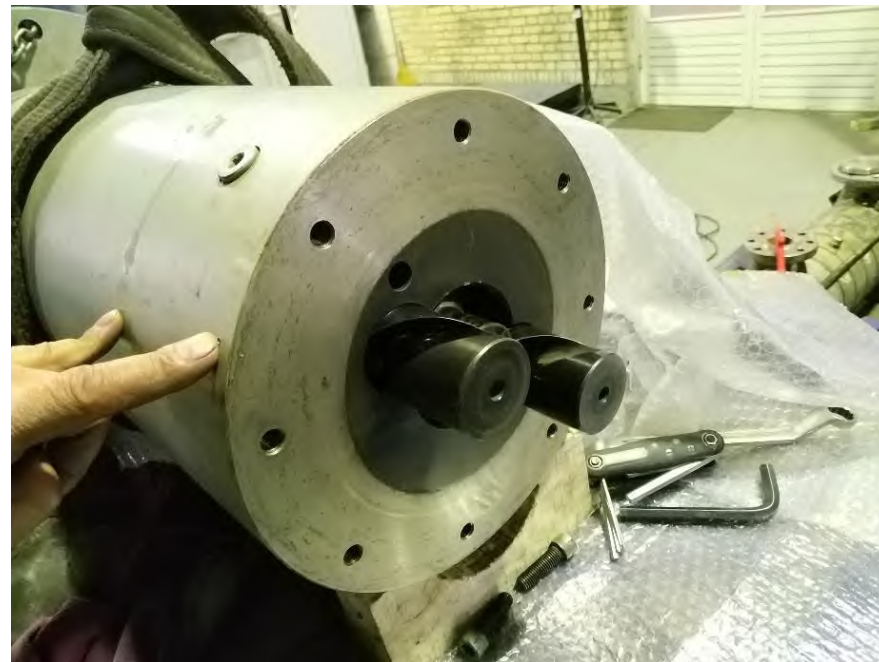

Description	Specification	 <p>O&M شرکت بهره برداری و تعمیراتی مینا</p>
<p>Vertical Line shaft cooling water pump</p>	<p>Hyosung VMF 1400-1250 18000 m³/hr – ۲۰m – 500 rpm</p>	

بازسازی پمپ شامل ساخت و تعویض ژورنال بیرینگ ها ، اسلیوها - ران اوت گیری و سنگزنی شفت ها - پوشش دهی بلموس - بالانس پروانه ها و نظارت بر مونتاژ و دمونتاز پمپ

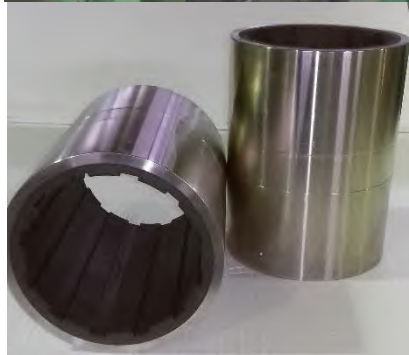

Description

Specification

High pressure multistage pump
(RO)

Awamura – Japan
33 m³/hr – 657 m



تعویض رینگ های سایشی - تعویض بوش ها - ساخت بالانس درام - اصلاح دیفیوزرها - اصلاح محفظه های مکش و رانش - تعویض بیرینگ ها - اصلاح پروانه ها - تعویض سیل مکانیکی - بالانس مجموعه شفت و قطعات روتاری



Description	Specification	
High pressure multistage pump	Caprari PMT 100-9A 100 m ³ /hr – 400 m	

تغییر هیدرولیک پمپ طبقاتی فشار قوی از ۹ طبقه به ۵ طبقه به روش بای پس سیال با هدف حفظ حداکثر سادگی در بازسازی و تعمیرات مجدد - حذف ۴ عدد دیفیوزر به منظور حفظ راندمان و صرفه جویی در انبارش قطعات - بالانس مجموعه روتور اسمبلی در عین نو بودن پمپ.



Description	Specification	 زرین برگ پرشیا
High pressure multistage pump	KSB MTC A 65/5 66 m3/hr – 310 m	

ساخت اسلیو و بوش های سیلیکون کارباید - ساخت و تعویض محور - ساخت و تعویض پروانه های ساکشن و دیسشارژ - ساخت قالب فرم دهی شیت متال های دفیوزر دفرمه شده - نشتی گیری محفظه ها دارای حفره های متعدد خوردگی ، بالانس مجموعه محور و قطعات روتاری - مونتاژ و دمونتاز

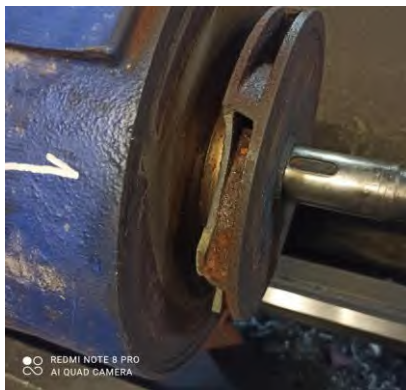

Description	Specification	 زرین برگ پرشیا
High pressure multistage pump	KSB MTC 32/9 12 m3/hr – 219 m	

ساخت اسلیو و بوش های سیلیکون کارباید - ساخت و تعویض محور - ساخت و تعویض پروانه - نشتی گیری محفظه ها ، بالانس مجموعه شفت و قطعات روتاری - مونتاژ و دمونتاز

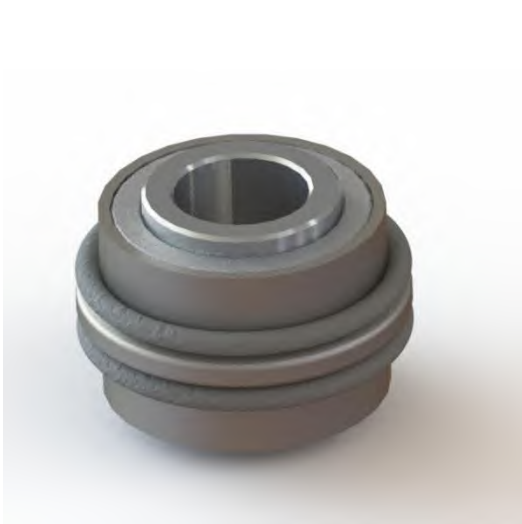

Description	Specification	 زرین برگ پرشیا
High pressure multistage pump	KSB MTC 50/10 12 m ³ /hr – 367 m	

ساخت اسلیو و بوش های سیلیکون کارباید - ساخت و تعویض محور - ساخت و تعویض پروانه - نشتی گیری محفظه ها ، بالانس مجموعه شفت و قطعات روتاری - مونتاژ و دمونتاز



Description	Specification	
Rotary joint manifold	Maier DZA 3100 F-14	

دمونتاژ مجموعه و بررسی آسیب وارده در محل قرارگیری پکینگ ها روی محور متحرک - پوشش دهی محل آسیب دیده بروش پاشش حرارتی و سنگزنی محل پوشش - ساخت و تعویض فلنچ - مونتاژ نهایی - تست ۴۰ بارنیترون



Description	Specification	 شرکت مهندسی رعد آب جنوب South Raadab Engineering co.
Multistage HP pump – (RO) (Mixed Flow) - Duplex	Fedco mixed flow horizontal sea water multistage pump - 8 Stage 300 m3/hr – 400 m	

رفع نشتی تمام محفظه ها و طبقات و ساخت محور - بازسازی پروفیل پروانه ها و ساخت و تعویض اسلیو ، بوش ها و تعویض رینگ های سایشی با متریال Peek



Spare Part Manufacturing and Repair



Art Manufacturing

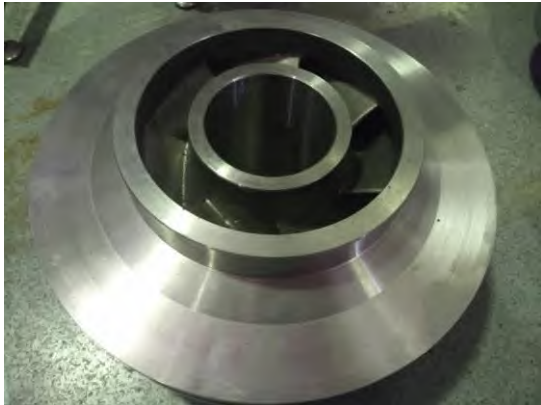

Duplex investment casting-400 mm
Q=500 m³/hr H=600 m (4 stages)



Duplex investment casting-230 mm
Q = 100 m³/hr P=40 bar (5 stages)

Art Manufacturing

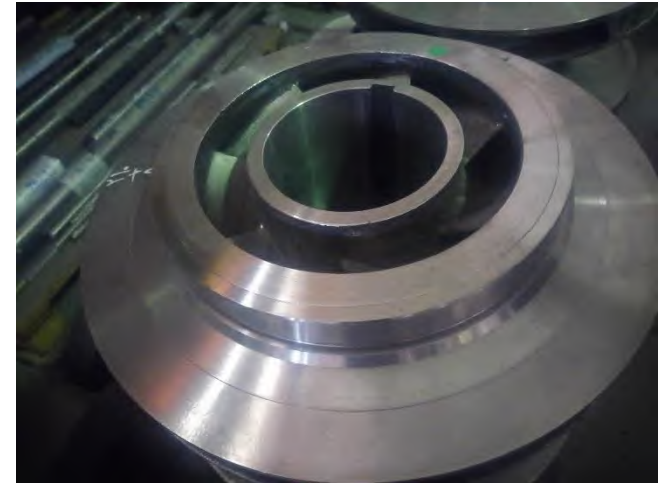
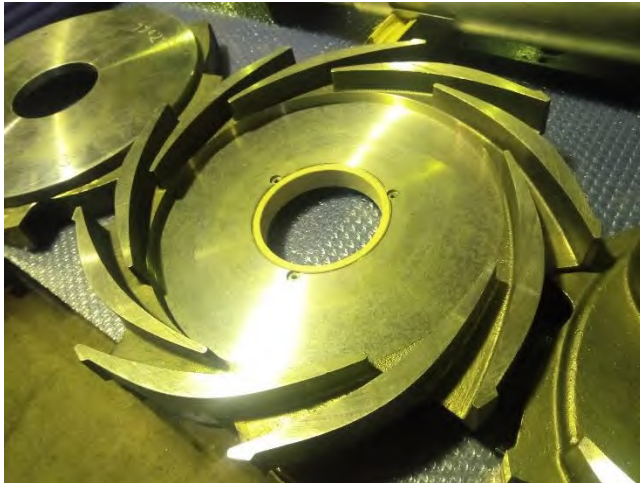

Duplex investment casting-330 mm
 $Q = 320 \text{ m}^3/\text{hr}$ $P=60 \text{ bar}$ (4 stages)

Art Manufacturing



Duplex Investment Casting
250 m³/hr – 40 bar

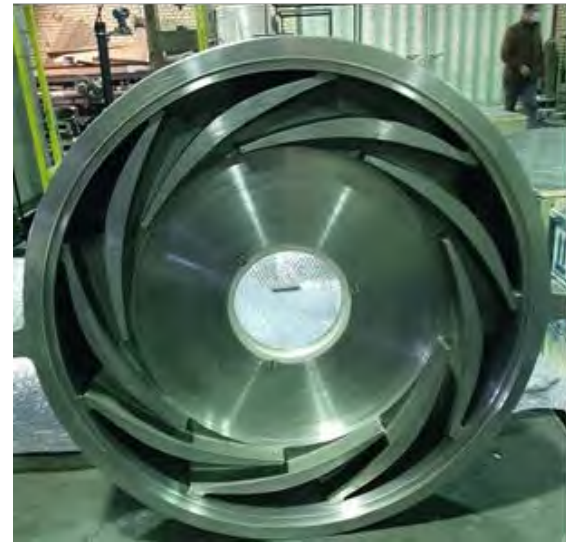

Duplex Investment and Sand Casting
320 m³/hr – 60 bar

Art Manufacturing

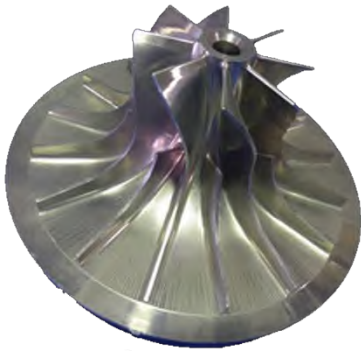

316 machining high speed pumps



Investment casing - High speed pump impeller

Art Manufacturing



17-4PH Machining High speed pumps Inducer

Art Manufacturing



Pelton Turbine

Description	Specification	
<p>FEDCO & ERI Turbo Charger For Sea Water (16000 rpm)</p>	<p>Super Duplex Rotor Silicon Carbide Bush PEEK Trust Bearing</p>	

ساخت قطعات توربوشارژر - روتور، یاتاقان ژورنال و تراست بیرینگ

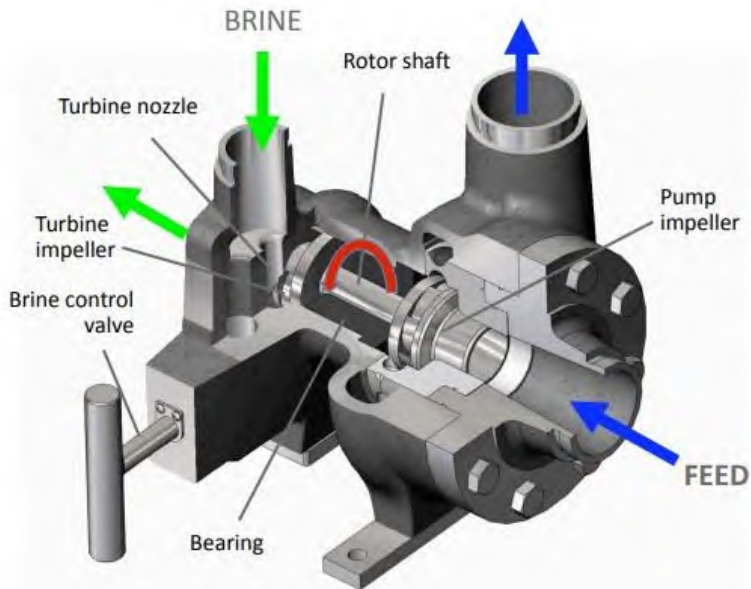

Art Manufacturing

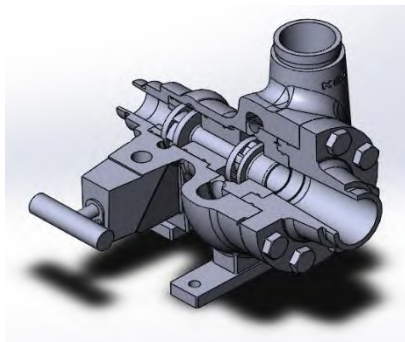
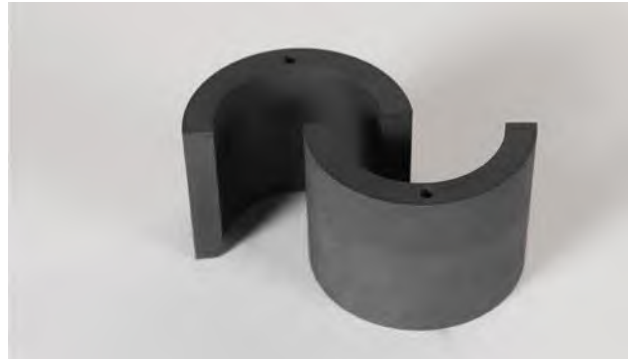

Turbocharger parts
Rotor-Bearing-etc.

Description	Specification	
<p>FEDCO & ERI Turbo Charger For Sea Water (16000 rpm)</p>	<p>Super Duplex Rotor Silicon Carbide Bush PEEK Trust Bearing</p>	

ساخت قطعات توربوشارژر - روتور، یاتاقان ژورنال و تراست بیرینگ

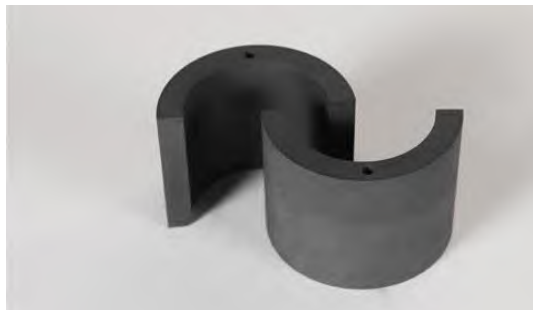
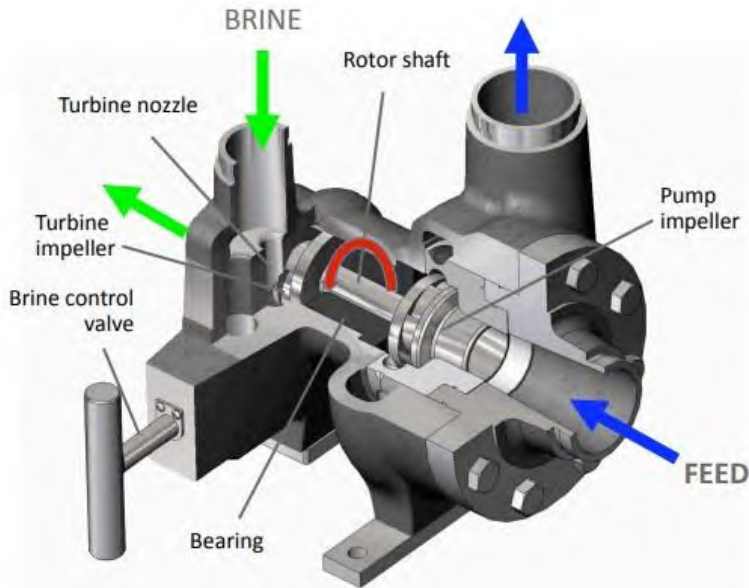

Art Manufacturing



Anti corrosion Impeller

Art Manufacturing



Sand casting made impeller

Art Manufacturing



Cast Iron made Impeller

Art Manufacturing

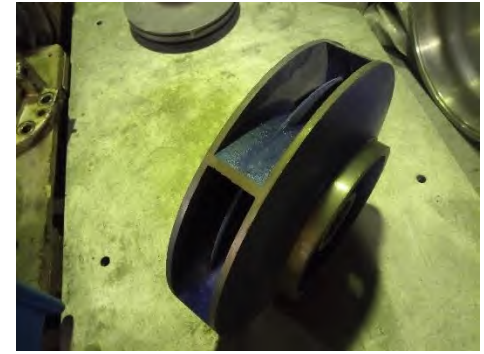
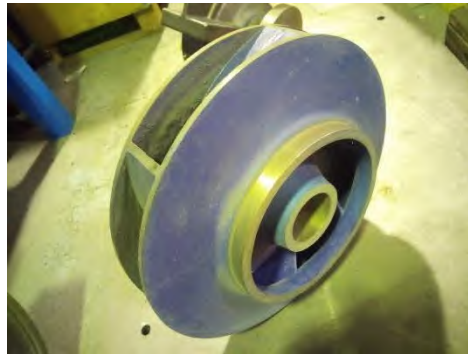
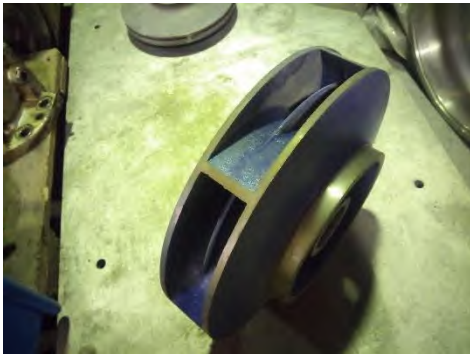

Double Suction Impeller

Art Manufacturing

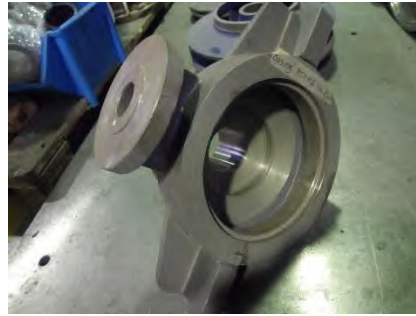

Cast Iron made Impeller

Art Manufacturing



Cast Iron made Impeller

Art Manufacturing



Parts of Vertical Turbine Pump

Art Manufacturing



Sundyne Pump Parts

Art Manufacturing



Peek Parts

Vibration Analysis



عارضه یابی و تشخیص عیب با استفاده از روش ها و ابزارهای علمی و نوین آنالیز ارتعاشات

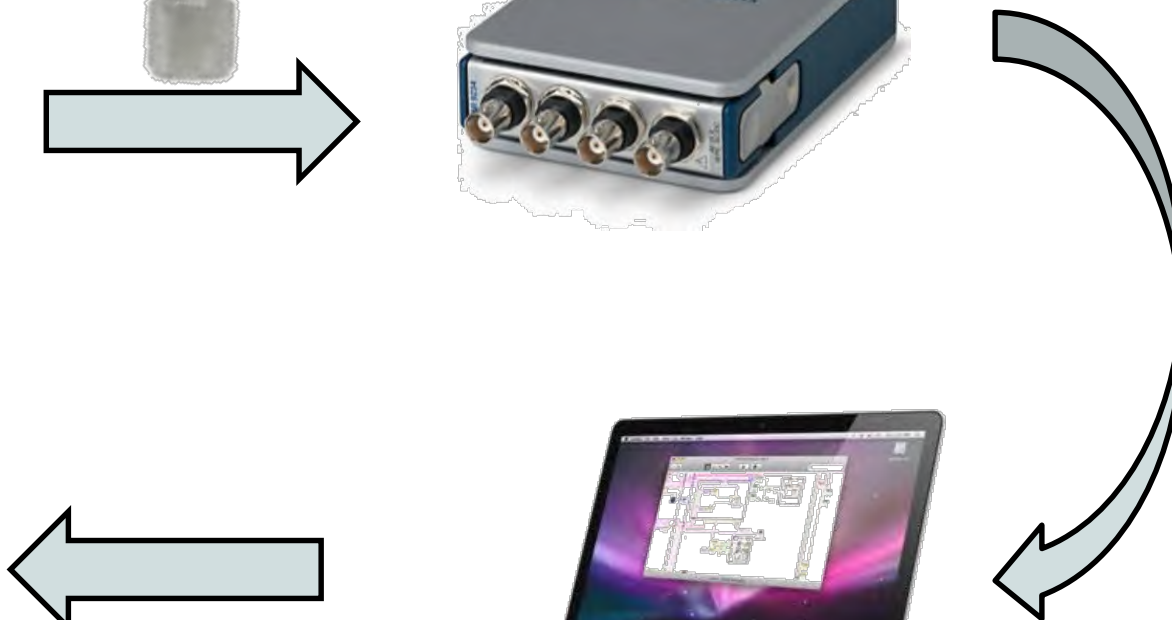
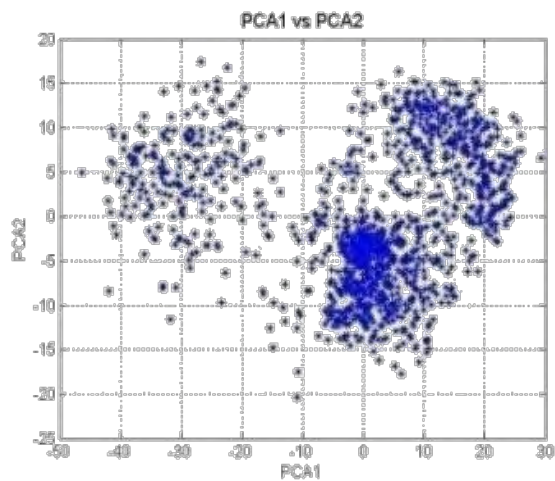

Certificates



